

# SWIT®

# NDI EFP

## Multi-Camera Production System

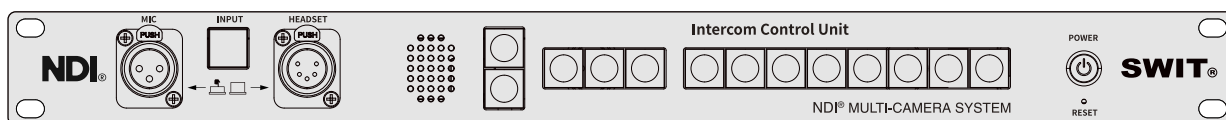
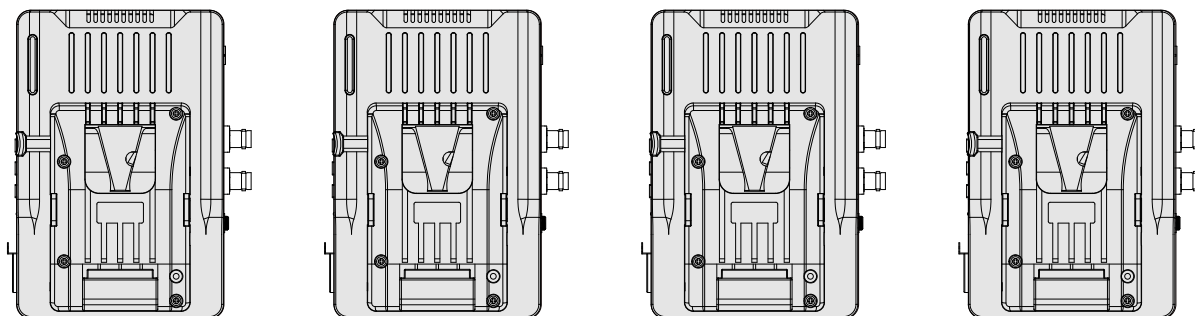

# User Manual

Thank you for purchasing SWIT products!  
Please read this manual carefully before using.

Ver:C

# Contents

Statement .....	3
Safety Precautions .....	4
Introduction .....	5
Features .....	5
Index of Parts and Functions .....	6
The Camera Adaptor .....	6
The Intercom Control Panel .....	7
Get Started .....	8
1. System Connection .....	8
2. IP setup .....	9
Webpage Settings - Camera Adaptor .....	10
1. Channel - Camera Channel configuration .....	10
2. Channel - Return Video Source Select .....	10
3. Channel - NDI Group Setting .....	11
4. Channel - External Sources .....	11
5. Channel - Advanced Settings .....	12
6. Network - Change IP address .....	12
7. User Admin - Log-in ID and Password Setting .....	13
8. Firmware Update .....	13
Webpage Settings - Intercom Control Panel .....	14
1. Channel - Assign Camera Adaptors .....	14
2. NDI settings .....	14
Indicators .....	15
Troubleshooting .....	16
Specifications .....	17
Dimensions .....	18
Packing List .....	18

# Statement

Any internal technology of this product (including hardware equipment, software design, and product trademark) is protected by law, and any violation of the intellectual property rights of this product will be investigated for legal responsibility.

All the company's brands and trademarks in this product are protected by law. All brands and trademarks of other companies involved in the product are legally protected by their owners.

In order to better serve the majority of users, the company's products will continue to improve and develop, and the company reserves the right to modify and improve the products described in this manual without prior notice.

The warranty period of this product is two years, and the following conditions are not covered by the warranty:

- (1) Man-made damage such as appearance wear and tear;
- (2) Product failure or damage caused by failure to use, maintain and store according to the instructions;
- (3) When used in a special environment, the signal quality will be attenuated;
- (4) Product damage caused by using a non-product matching power adapter;
- (5) Other faults not caused by product design, technology, manufacturing, quality and other problems or unauthorized disassembly, repair or replacement parts etc.

If users find problems during use or have suggestions and requirements for our products, please contact us by telephone, fax, email, etc.

## **SWIT Electronics Co., Ltd.**

Address: 10 Hengtong Road, Nanjing Economic and Technological Development Zone,  
Nanjing 210038, P.R. China

Phone: +86-25-85805753

Fax: +86-25-85805296

Email: [contact@swit.cc](mailto:contact@swit.cc)

<http://www.swit.cc>

# Safety Precautions

Please follow the safety precautions in this manual and operate in the correct way. Our company guarantees that this product can be used for a long time, but the following situations are not included:

- 1.Unauthorized disassembly, maintenance or replacement of parts and other operations.
- 2.Damage caused by accident, including but not limited to lightning, fire, exposure to rain or moisture.
- 3.The type of power source being used is not within the voltage range allowed for this product.

## **Warning**

- ◆ Do not let any liquid splash on the product.
- ◆ In order to avoid electric shock, please do not block or paste the ventilation holes on the product, do not remove the product cover, or put pins, iron wires, and foreign objects into the gaps in the ventilation holes.
- ◆ To reduce the risk of electric shock or fire, do not place this product in rain or moisture.

## **Danger**

- ◆ Before connecting with any equipment, please turn off the power first, and then operate.
- ◆ Power socket: To avoid short-circuit electric shock or fire, please confirm that the type of power socket used is within the voltage range of this product.
- ◆ Power cord: Do not place any objects or heavy objects on the power cord to prevent the power cord from being pressed or strained.
- ◆ Power load: Do not exceed the load on the wall socket, extension cord or other porous sockets to avoid fire or electric shock.
- ◆ Lightning: To avoid lightning or long time without use of the product, please remove the plug/external battery.

## **User environment**

- ◆ Do not place this product in an unstable place, the product may be seriously damaged due to falling.
- ◆ Do not place this product near equipment that is too hot, too cold or too humid, or that will cause a strong magnetic field.

## Introduction

The SWIT NDI EFP system consists of camera adaptors EC-N200 (up to HD) or EC-N200-4K (up to 4K) and an intercom control panel ET-N80 with all the essential accessories for one-stop setup.

The EC-N200 camera adaptor takes 3G-SDI input from cameras, encoded to an HD NDI stream over an IP network, and the EC-N200-4K camera adaptor takes 12G-SDI input, and encodes to 4K NDI. Both of the HD and 4K versions support NDI PGM source decoded and monitoring output via HDMI. You can use any on-camera monitors with HDMI input, to monitor local camera video and return PGM video in pic-in-pic mode. The control buttons on the adaptor are available for intercom volume adjustment and Push-to-talk with the director. There's on-board TALLY light for cameramen and also extended TALLY light for the anchor. The camera adaptors support PoE power and V-mount battery power as well.

The ET-N80 intercom control panel can be assigned with up to 8 camera adaptors, and supports link connection for more channels or for external 3rd party intercom system by 4-wire connector. Directors can talk to every cameraman individually by pushing button numbers or announce everyone by the ANN button, instead of selecting intercom channels from webpages.

The NDI EFP system has respected all the operation habits of SDI/Fiber EFP system, and greatly simplified cable works by using NDI IP solution. You can use any ENG cameras to build up a pure NDI production system, and all the intercom, TALLY, return video are based on NDI, the high quality and low latency IP video solution with reasonable network bandwidth.

## Features

- ◆ Encode camera SDI to high bandwidth NDI, HD up to 150Mbps and 4K up to 250Mbps.
- ◆ Decode PGM NDI in every camera adaptor and display local video and return video together.
- ◆ Full duplex intercom between cameramen and director.
- ◆ The director can select camera numbers to talk individually or press ANN to talk to everyone.
- ◆ The cameraman can initiate the call to director.
- ◆ Provide dual colors on-board TALLY light and external TALLY light set on the front of the camera.
- ◆ The camera adaptor supports DC-IN power, V-mount battery power and PoE power.
- ◆ The intercom control panel can be connected into 3rd party intercom system.

## The Camera Adaptor EC-N200 / EC-N200-4K

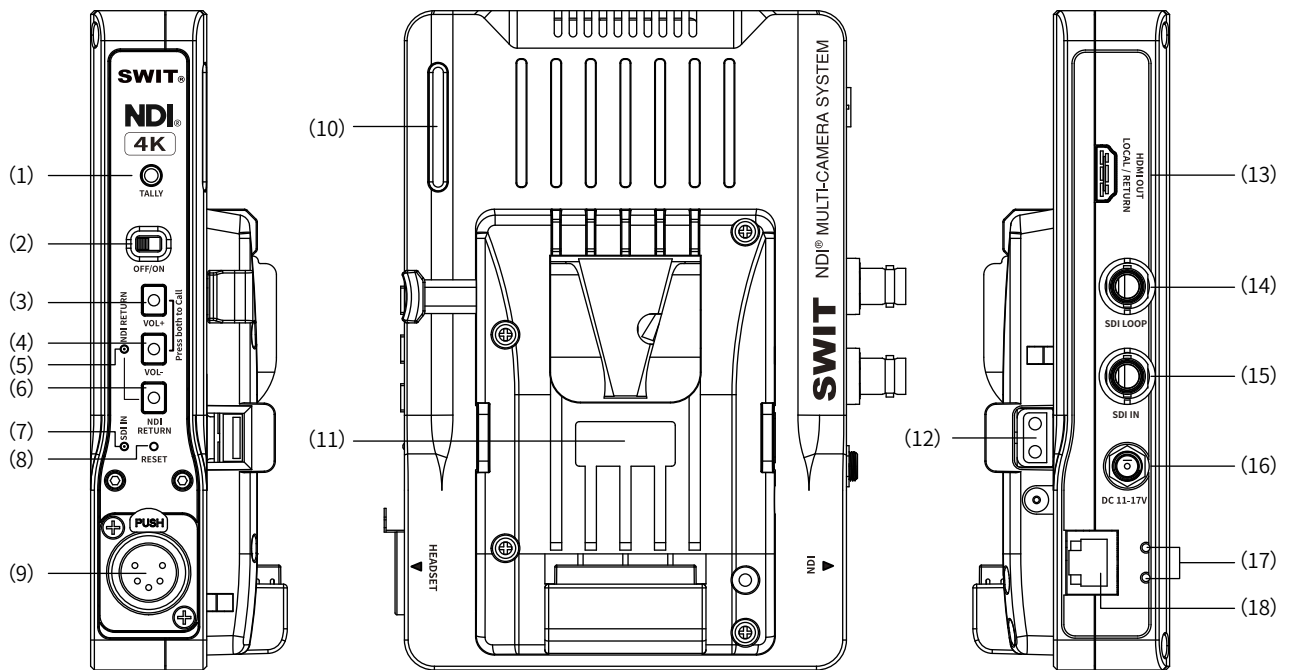

(1) External TALLY output, 3.5mm jack

(2) Power ON/OFF switcher

(3) Volume Up \*

(4) Volume Down \*

\*Press both to call director

(5) NDI return video Indicator

(6) NDI return video switcher, press in turn:

Local video → Local/Return PIP → Return Video

(7) SDI input lock indicator

(8) Press the pin to reset

(9) 5-pin XLR headset input

(10) On-board TALLY light

(11) V-mount battery plate (Gold mount option)

(12) D-tap power output from battery

(13) HDMI Monitor out for Local / Return video

(14) SDI loop output\*

(15) SDI input\*

\*EC-N200 up to 3G; EC-N200-4K up to 12G

(16) DC 11-17V input, 5.5/2.1mm jack

(17) RJ45 network cable fixer install position

(18) Gigabit high bandwidth NDI interface \*

\*EC-N200 up to 1080p50/60, 150Mbps

EC-N200-4K up to 2160p50/60, 250Mbps

## The Intercom Control Panel ET-N80

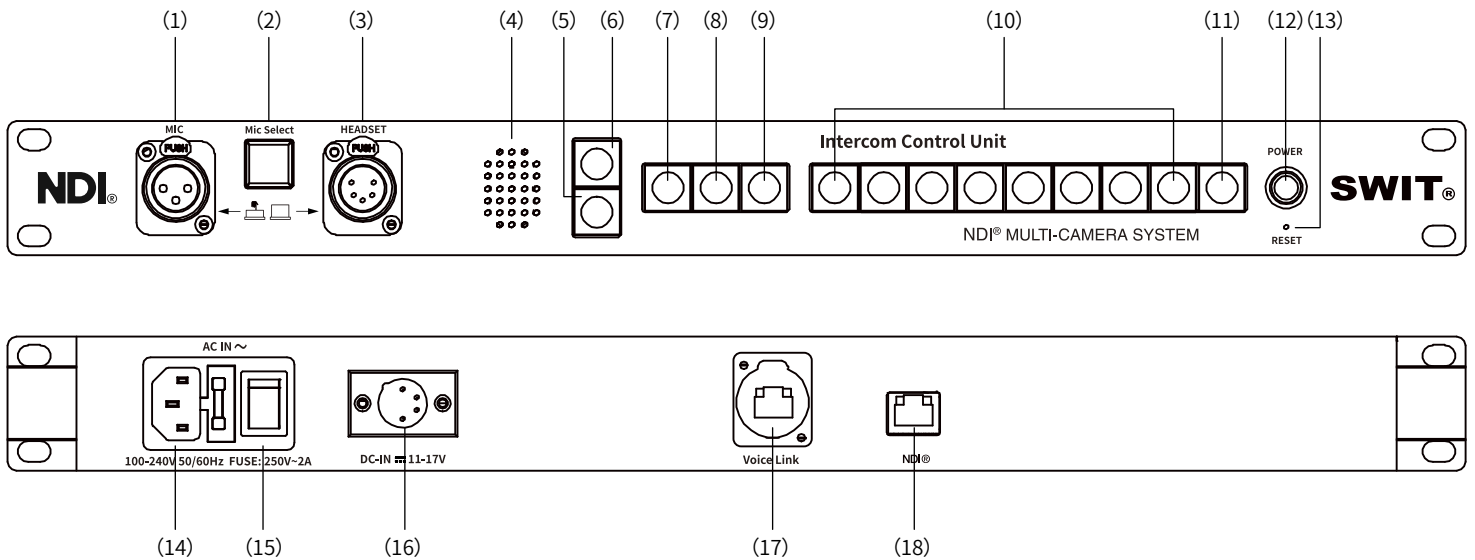

- (1) 3-pin XLR Microphone socket
- (2) Mic/Headset switching button  
Press down to switch from Headset to Mic
- (3) 5-pin XLR Headset socket
- (4) Speaker, output when switching to Mic
- (5) Volume Down
- (6) Volume Up
- (7) ANN: Announcement mode  
Press to talk to all camera channels
- (8) MIC OFF: Turn off the Microphone input
- (9) MUTE: Turn off the Headphone/Speaker output
- (10) 1-8: Camera Channels 1-8  
Press the numbers to talk individually
- (11) 4-Wire: External intercom channel  
Press to take over external intercom

- (12) Power ON/OFF switcher
- (13) Press the pin to reset
- (14) AC 100-240V 50/60Hz input
- (15) AC ON/OFF switcher
- (16) DC 11-17V input, 4-pin XLR
- (17) External intercom connect, RJ45 4-Wire \*

\* Pin definition:

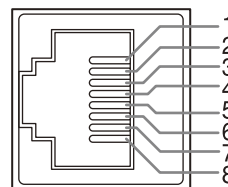

Pin 1	Null
Pin 2	Null
Pin 3	Audio OUT +
Pin 4	Audio IN +
Pin 5	Audio IN -
Pin 6	Audio OUT -
Pin 7	Null
Pin 8	Null

- (18) NDI network connect, RJ45

### 1. System Connection

Connect all the camera adaptors and the intercom control panel to the NDI network.

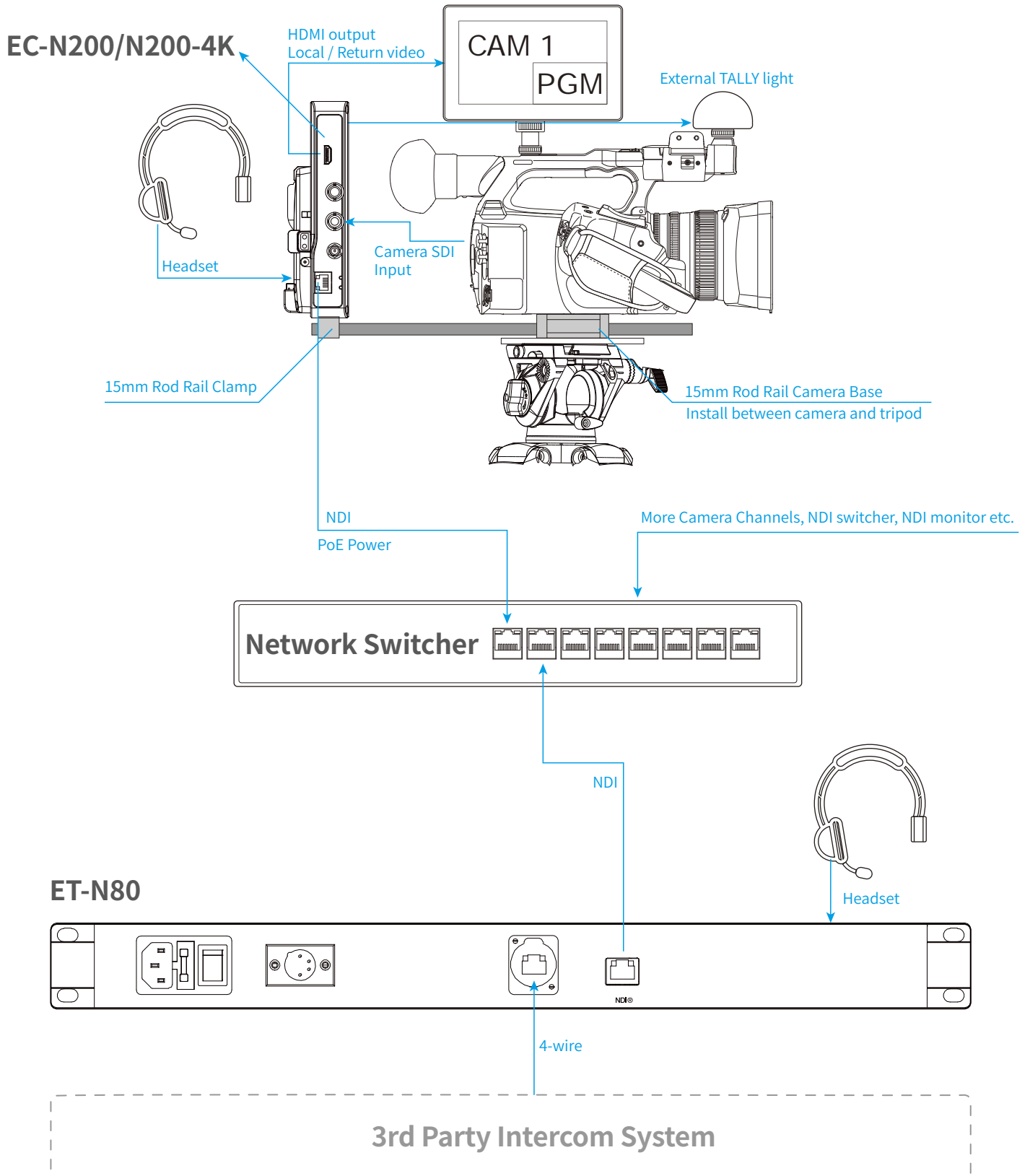



## 2. IP Setup

The camera adaptor and intercom control panel has factory default IP address:

Device	Default IP
EC-N200/N200-4K	192.168.1.15X
ET-N80	192.168.1.101

You can find the default IP address on the product label

Set computer IP address to the same segment, and connect directly with the device or through network switcher, by straight through RJ45 cable.

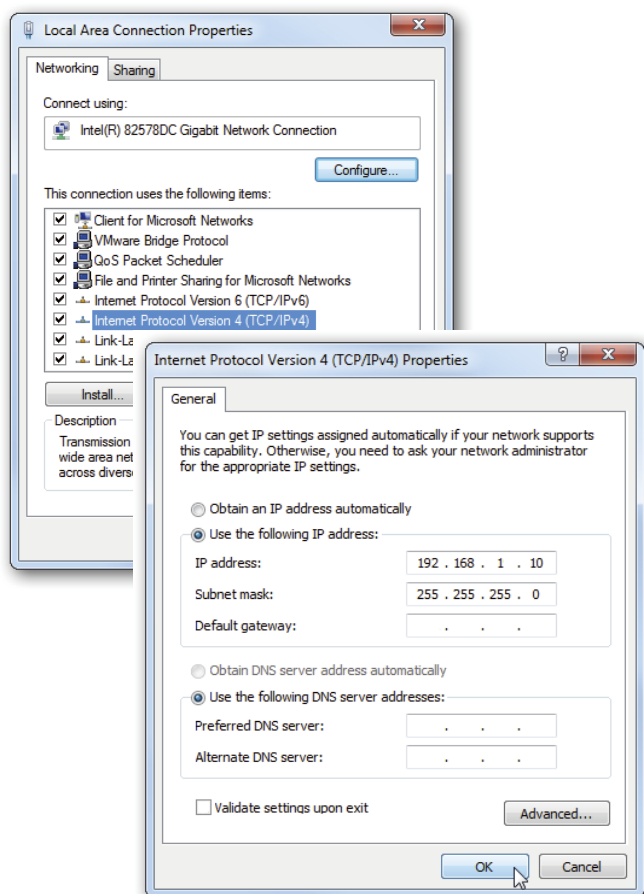

Launch web browser on the computer, input 192.168.1.15X to enter configuration webpage of the camera adaptor, and input 192.168.1.101 to enter configuration webpage of the intercom control panel.

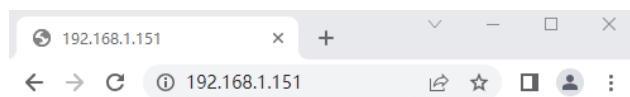

Input User ID and password to log-in configuration webpage

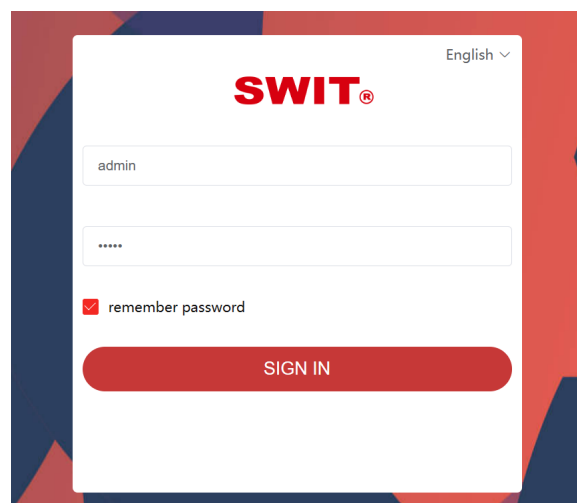

Item	Default
User ID	admin
Password	admin

## 1. Channel - Camera Channel configuration

The screenshot shows the SWIT web interface for channel configuration. On the left, a 'Status Info List' contains several metrics: Headphone Volume (80%), Device Name (EC-N200-4K\_00023027), Source Name (camera 45), Channel No. (Channel 4), Resolution (N/A), and Field Rate (N/A). The main configuration area is titled 'Channel configuration' and includes fields for Device Name, MCU IP (192.168.1.101), Source Name (camera 45), and Channel (Channel 4). A 'MCU Webpage' button is present next to the MCU IP field. At the bottom, there are 'Rename and Apply' and 'Apply' buttons.

## 2. Channel - Return Video Source Select

The screenshot shows the 'Return Source' selection screen in the SWIT web interface. It features a search bar and a table of video sources. The first source, 'MINI-4C255F57 (MIX 1)', is selected with a red checkmark. Other sources include 'MINI-4C255F57 (Teleprompter)', 'MINI-4C255F57 (PHONES)', 'MINI-4C255F57 (MIX 4)', and 'MINI-4C255F57 (MIX 3)'. Each source has a 'Select' button.

All NDI sources in current network

Select one source as "Return video" to output via HDMI to camera top monitor

## 3. Channel - NDI Group Setting

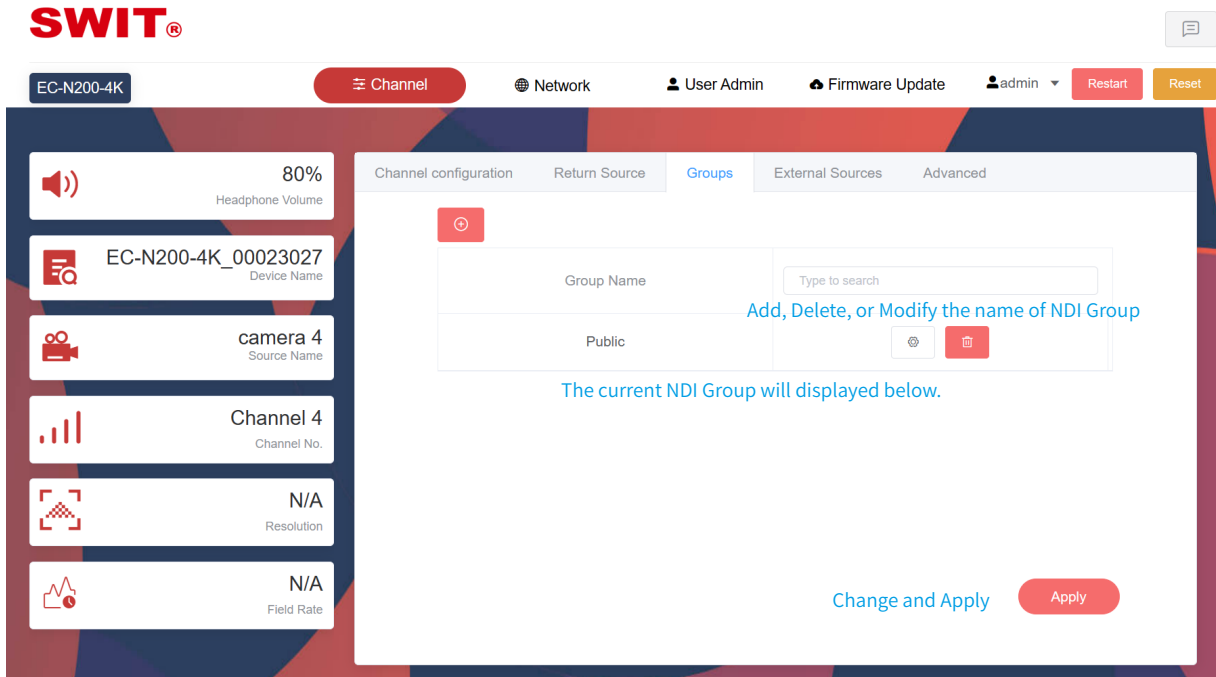

## 4. Channel - External Sources

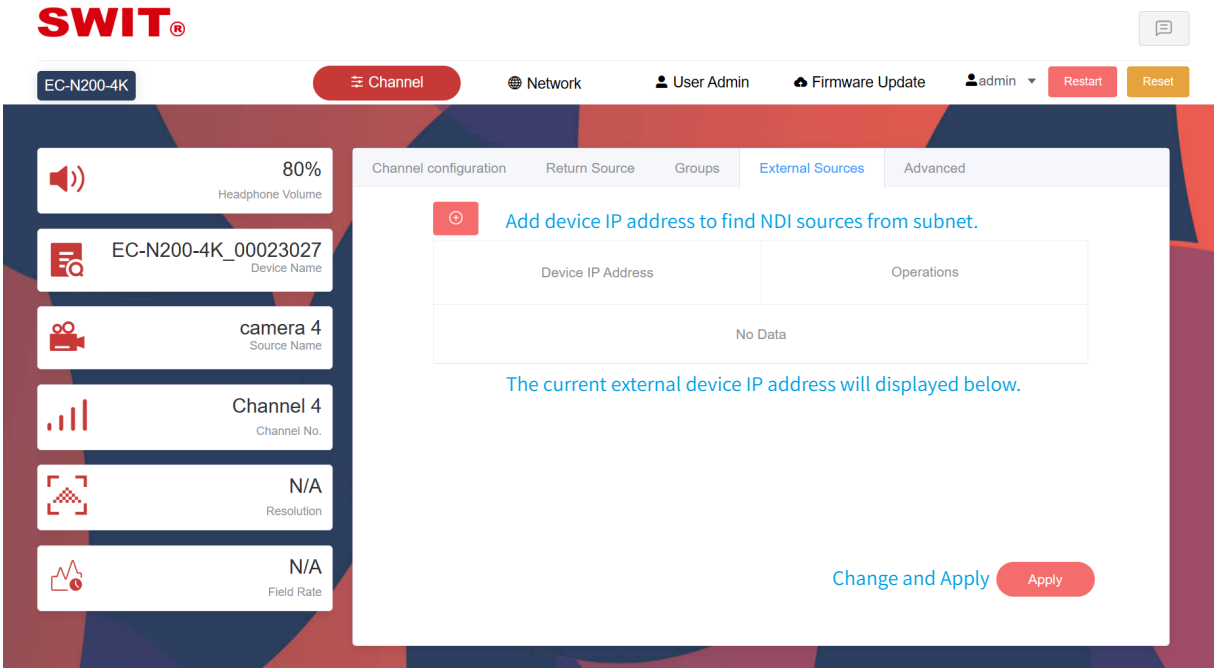

## 5. Channel - Advanced Settings

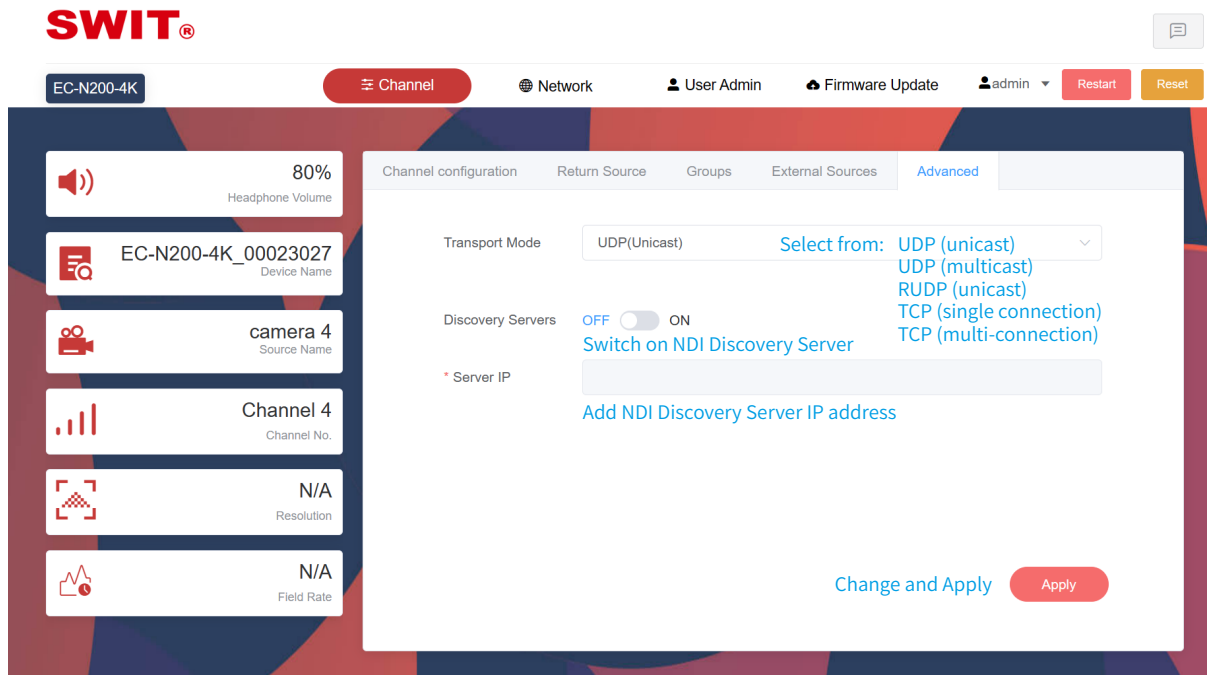

## 6. Network - Change IP address

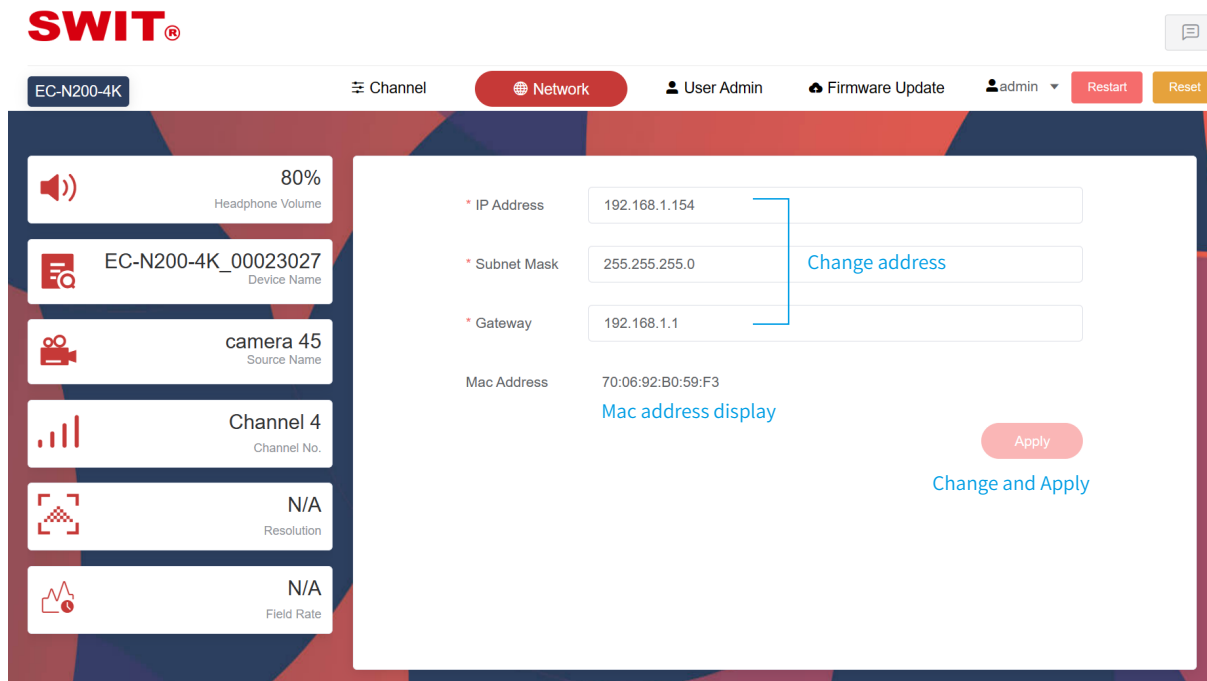

## 7. User Admin - Log-in ID and Password Setting

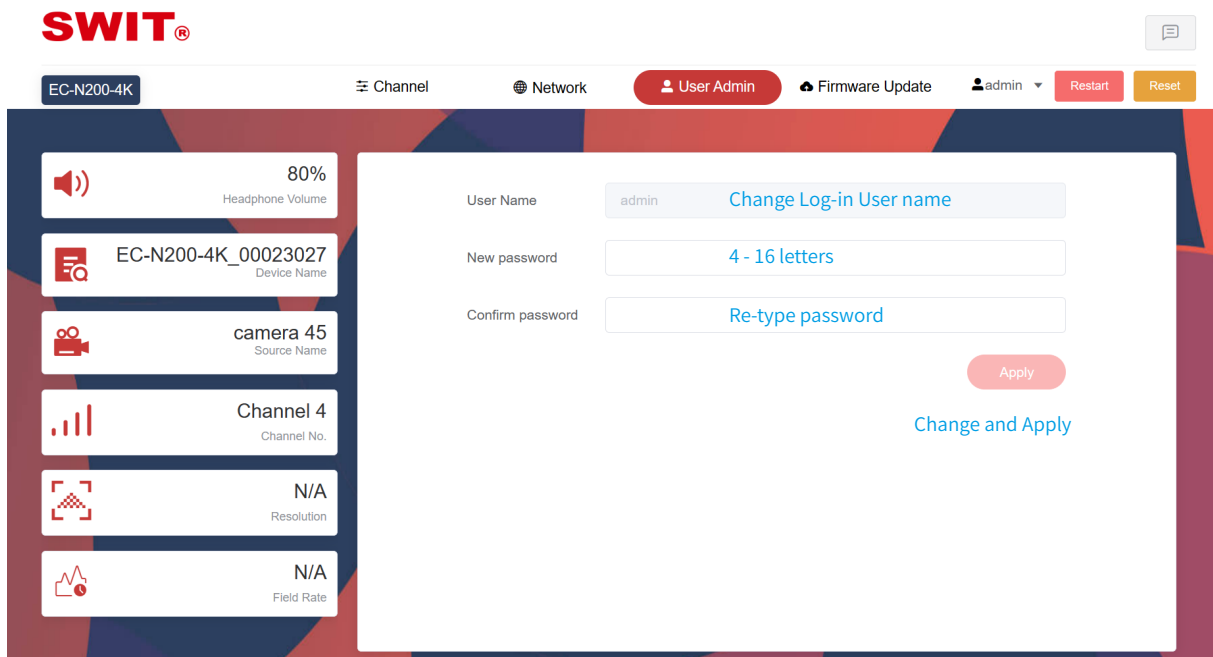

## 8. Firmware Update

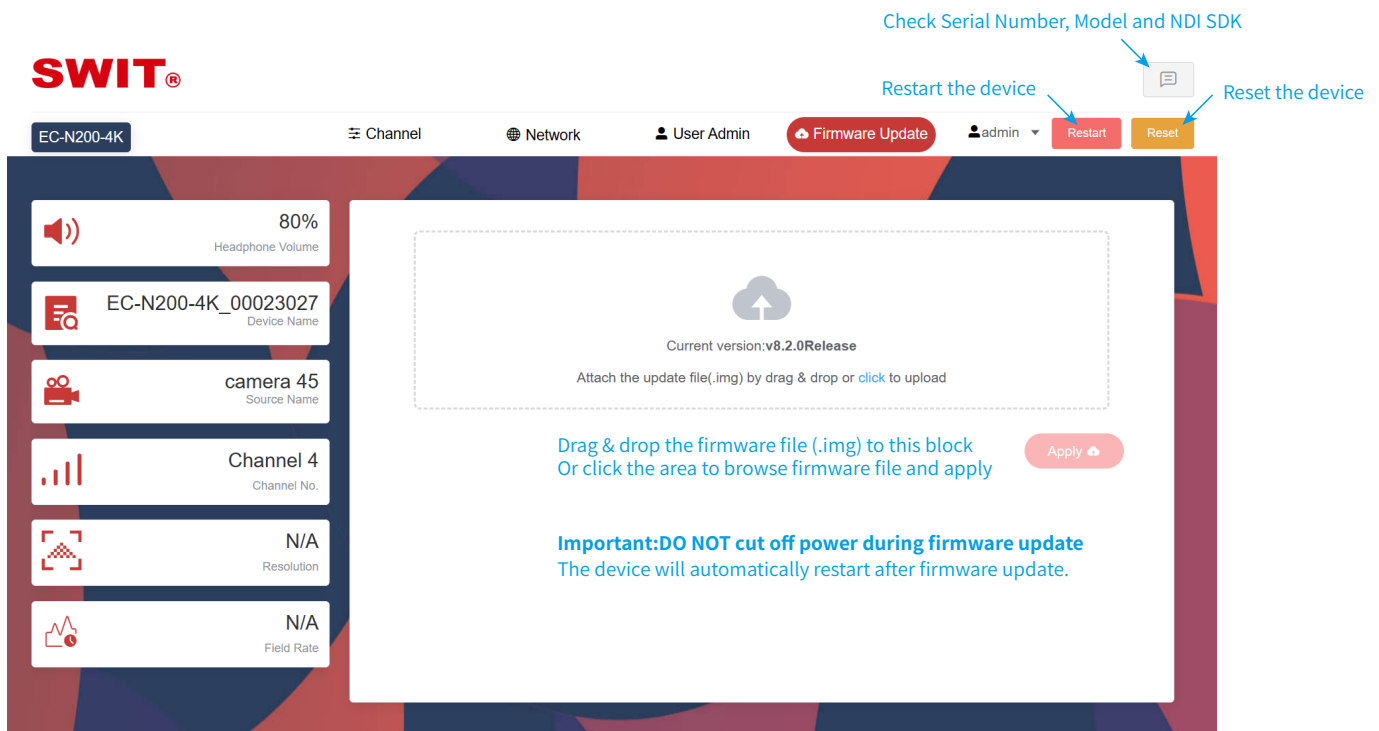

# Webpage Settings - Intercom Control Panel

## 1. Channel - Assign Camera Adaptors

SWIT®

ET-N80 Channel NDI User admin Upgrade admin Restart Reset

**Search adapter** Import →

Type to search Search adapter

Search IP address or device name to add Camera adaptors

**MCU Configure** Delete All

Recycle Bin Assigned devices: Display color - The device is online  
Display grey - The device is offline

Channel 1 Channel 2 Channel 3 Channel 4

EC-N200-4K\_00851111 EC-N200-4K\_00852222 EC-N200-4K\_00854444

192.168.1.151 192.168.1.152 192.168.1.154

Channel 5 Channel 6 Channel 7 Channel 8

Drag the devices to move positions (not available for the offline devices)

Configure Network Apply Change and Apply

Click to remove the device

## 2. NDI Settings

SWIT®

ET-N80 Channel NDI User admin Upgrade admin Restart Reset

**NDI Configure**

Groups Add, Delete, or Modify the name of NDI Group

Group name Group name Public

External Sources Add device IP address to find NDI sources from subnet.

Device IP Address Device IP Address

192.168.1.102 192.168.1.103





Discovery Servers Add NDI Discovery Server IP address

Server IP





Apply Change and Apply

## Indicators

### 1. The Camera Adaptor EC-N200/N200-4K

Singal Indicator	Status/Color	Instruction
	On	Powered on
	Off	Device not get powered
	Red	No SDI input recognized
	Green	SDI input recognized
	Red	No return NDI source recognized
	Green	Return NDI source recognized
	Red	The camera channel is PGM
	Green	The camera channel is PWV
	Amber	The camera channel is both PGM & PWV
	Red	The camera channel is PGM
	Green	The camera channel is PWV
	Amber	The camera channel is both PGM & PWV

### 2. The Intercom Control Panel ET-N80

Singal Indicator	Status/Color	Instruction
	On	Powered on
	Off	Device not get powered
	Red	3-pin Microphone actived
	Green	5-pin Headset actived
	Red	The camera channel connected
	Green	The camera channel intercom actived
	Red flashing	The camera channel is calling
	Red	External intercom system is connected
	Green	External intercom channel is actived
	Off	Individual intercom mode
	Green	Announcement mode
	Off	Microphone is turned on
	Green	Microphone is turned off
	Off	Earphone or Speaker is turned on
	Green	Earphone or Speaker is turned off

## Troubleshooting

Phenomenon	Possibility Reasons	Solutions
No NDI video from camera channels	Camera adaptor not get powered	Check power supply
	Camera SDI not connected	Check camera SDI cable
	Camera SDI format not supported	Check camera SDI format
	Network blocked	Check IP address of the camera adaptor
No return video display	Didn't select return video source	Camera adaptor-Channel-Return source
	Return video not switched on	Press Return button on camera adaptor
Intercom can't be connected	Low volume or Mic OFF or Mute	Check the button status
	Camera adaptor not assigned	Check the channel assign settings
Unable to launch web configue page	Wrong IP address	Check IP address of the device
	Web browser need refresh	Press Ctrl+F5 to refresh web browser
Unable to upgrade firmware	Firmware file error	Make sure the file name is correct
	The device is already latest firmware	Check the firmware version



## Specification

Camera Adaptor		EC-N200	EC-N200-4K
Input		3G-SDI × 1	12G-SDI × 1
Output		3G-SDI loop × 1	12G-SDI loop × 1
		HDMI 1.3 out × 1	HDMI 1.3 out × 1
		High bandwidth NDI × 1	High bandwidth NDI × 1
Video Formats	SDI	1080P (60/59.94/50/30/23.98/29.97/25) 1080I (60/59.94/50) 720P (60/59.94/50)	2160P (60/50/30/23.98/29.97/25) 1080P (60/59.94/50/30/23.98/29.97/25) 1080I (60/59.94/50) 720P (60/59.94/50)
	NDI	1080P (60/59.94/50/30/29.97/25) 1080I (60/59.94/50) 720P (60/59.94/50)	2160P (60/50/30/29.97/25) 1080P (60/59.94/50/30/29.97/25) 1080I (60/59.94/50) 720P (60/59.94/50)
	HDMI	1080P (60/59.94/50/30/23.98/29.97/25) 1080I (60/59.94/50) 720P (60/59.94/50)	1080P (60/59.94/50/30/23.98/29.97/25) 1080I (60/59.94/50) 720P (60/59.94/50)
DC Input		DC/ Battery 11~17V, 1.5A, PoE 42~57V, 0.5A	
Power		16W	
Environment		0°C~+40°C	
Size		139.23×176×52.5mm	
Weight		742g	

Intercom Control Panel		ET-N80
AC Input		100~240V, 0.5A
DC Input		11~17V, 1.5A
Power		16W
Environment		0°C~+40°C
Size		482.6×164.4×44.5mm, 1U rackmount
Weight		1.5kg

## Dimension

### EC-N200/N200-4K

Unit:mm

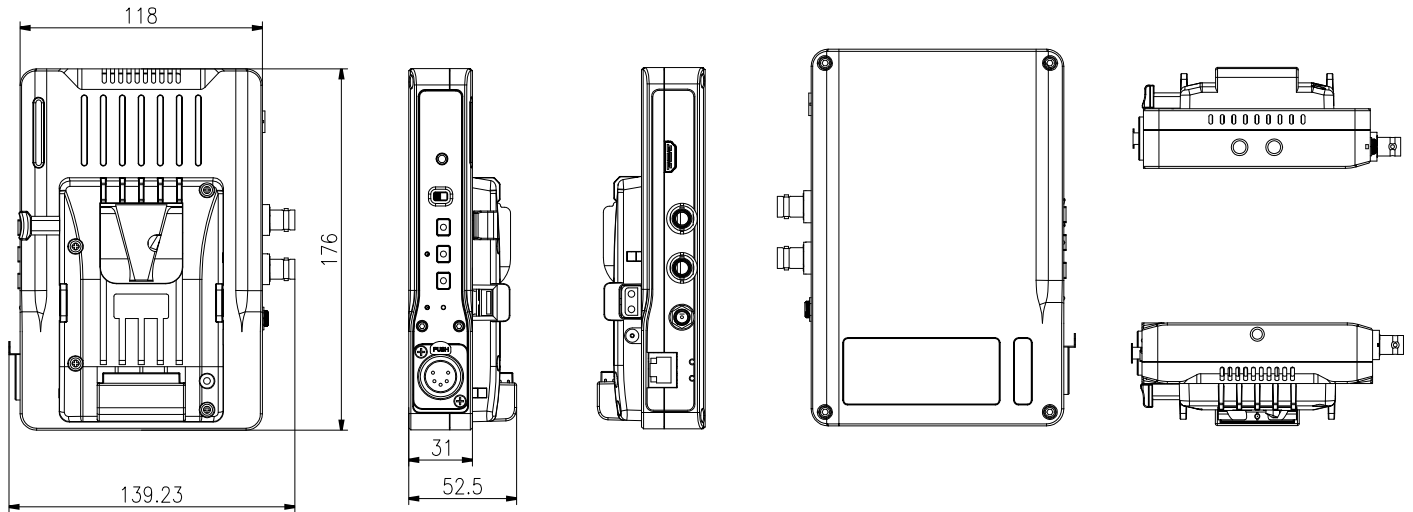

### ET-N80

Unit:mm

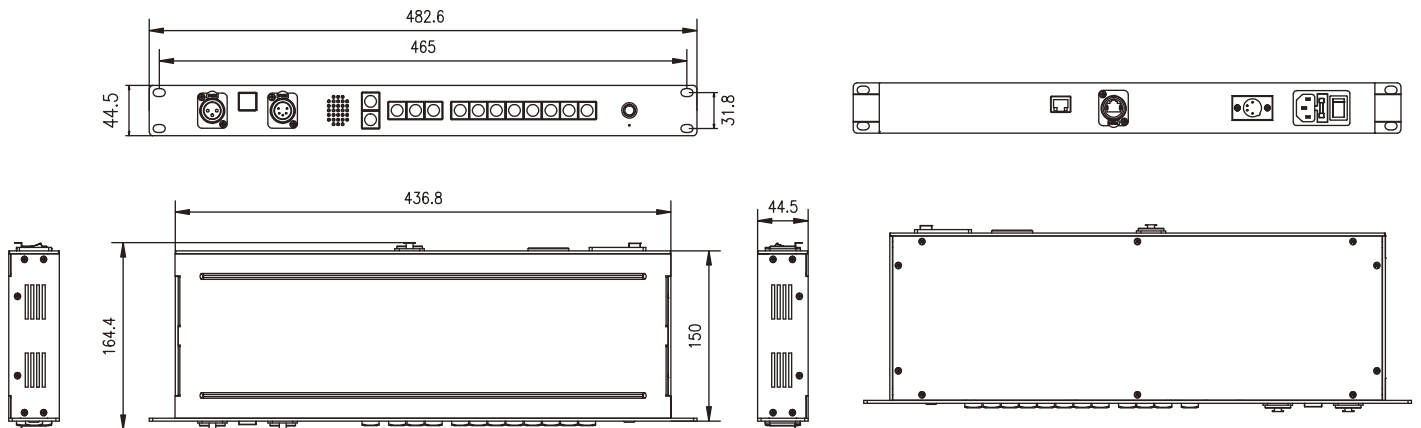

## Packing List

### EC-N200/N200-4K

Single ear headset (5-pin XLR)	×1
15mm rail rods	×2
Camera 15mm rail base	×1
Adaptor 15mm rail clamp	×1
External TALLY with cable and coldshoe	×1
RJ45 cable fixer	×1
D-tap to 5.5/2.1mm DC cable	×1
Carrying Case	×1

### ET-N80

Single ear headset (5-pin XLR)	×1
Swanneck Microphone (3-pin XLR)	×1
AC power cable	×1

**SWIT®**